

9 LABORATORY ACCESSORY



NORMAG - LABORATORY GLASSWARE



L 309 e.1

DRYING TUBES

They serve for drying of gas with suitable desiccants. To avoid sticking of the packing during the process, not shape resistant desiccants (e.g. phosphorus oxide) are mixed with supporting substances (e.g. glass wool or pumice).

Design B is fitted a lateral glass thread GL 14.

The lateral standard stopcock in design C has a 3 mm bore.

H	NS	Design	Catalogue No.
120	14/23	A	LSG 00515
120	29/32	A	LSG 00516
120	14/23	B	LSG 00518
120	29/32	B	LSG 00519
120	14/23	C	LSG 00515H
120	29/32	C	LSG 00516H

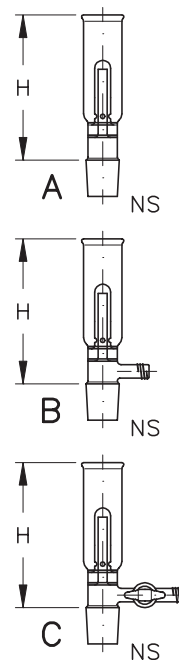

BUBBLE COUNTER

The volume of gases introduced into an apparatus must be easily controlled. In some cases, washing bottles cannot fulfil this task. As an alternative, a bubble counter can be used. It will be filled with a conventional blocking liquid up to the ring mark.

Design B is fitted a lateral glass thread GL 14.

The lateral standard stopcock in design C has a 3 mm bore.

H	NS	Design	Catalogue No.
140	14/23	A	LSG 00525
140	29/32	A	LSG 00526
140	14/23	B	LSG 00528
140	29/32	B	LSG 00529
140	14/23	C	LSG 00525H
140	29/32	C	LSG 00526H

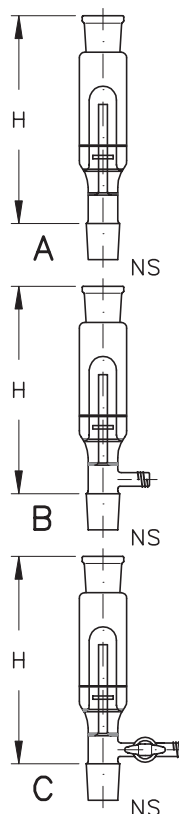

All ground joints are also available in other standard sizes, e.g. US-standard.

SAFETY/OVERPRESSURE VALVE

Safety/overpressure valves, with spring loaded spherical ground joint seal

When laboratory ground devices are used under vacuum or/and slight overpressure, the use of this combined overpressure safety valve can be recommended. These valves act as immediately closing safety valve under vacuum and they allow under overpressure the visual control of the bubble formation in the blocking liquid.

The real sealing is effected by a special designed spherical ground joint (cup and ball) on which an adjustable spring power acts. It is supported by a free to chose blocking liquid which should be higher viscous for vacuum operations.

The sealed climbing tube at the spherical ground cup serves as a guide and prevents that the liquid climbs back into the apparatus. Design B is additionally equipped with standard stopcock, bore 3 mm.

On request these valves are also available with spherical ground joints, spherical flanges or threads (instead of conical joint).



All safety/overpressure valves with spring loaded spherical ground seal are pre-set for an overpressure of 0.1 bar. Higher pre-set overpressures are available on request.

H	NS	GL	D	Design	Catalogue No.
210	14/23	18	-	A	LSG 00549 01
210	29/32	18	-	A	LSG 00549 02
215	14/23	18	11	B	LSG 00549H 01
215	29/32	18	11	B	LSG 00549H 02

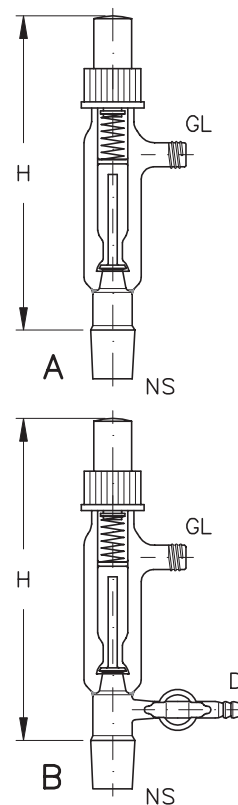

All ground joints are also available in other standard sizes, e.g. US-standard.

Safety/overpressure valves, without spring loaded spherical ground seal

In this variant, the sealing is effected by a special designed spherical ground joint (cup and ball), but the own weight of the ground hood acts only on the ground joint. It is supported by a free to chose blocking liquid which should be higher viscous for vacuum operations.

Design B is additionally equipped with standard stopcock, bore 3 mm.

H	NS	NS1	D	Design	Catalogue No.
230	29/32	14/23	-	A	LSG 00547 01
230	29/32	29/32	-	A	LSG 00547 02
235	29/32	14/23	11	B	LSG 00547H 01
235	29/32	29/32	11	B	LSG 00547H 02

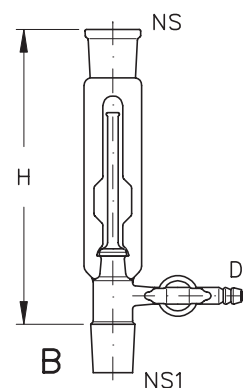
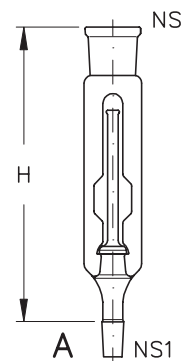

Safety/overpressure valve, for inert gas

This simplified variant of the safety/overpressure valves can only be used for non-toxic inert gases, due to its design (no visual gas outflow can be seen). An exact adjustment of the overpressure cannot be granted.

Connections olive D11.

Catalogue No. LSG 00550

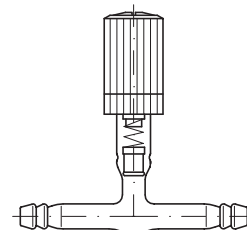

All ground joints are also available in other standard sizes, e.g. US-standard.

GAS COLLECTING VESSELS

These collecting vessels for gas are manufactured according to DIN 12 473 and fitted with standard stopcock either as single way, two way or three way stopcock. The three way stopcocks have an 120° angle bore. A rectangular label is fixed for marking on every tube.

On request gas collecting vessels with plastic coat are available (protection against breakage).



Gas collecting vessels with lateral threaded connection with septa and screw cap for sample withdrawal are available.

Capacity (ml)	H	Design	Catalogue No.
150	250	A	LSG 09071 01
150	375	B	LSG 09072 01
150	375	C	LSG 09073 01
350	300	A	LSG 09071 02
350	420	B	LSG 09072 02
350	420	C	LSG 09073 02
500	330	A	LSG 09071 03
500	425	B	LSG 09072 03
500	440	C	LSG 09073 03
1000	400	A	LSG 09071 04
1000	485	B	LSG 09072 04
1000	485	C	LSG 09073 04

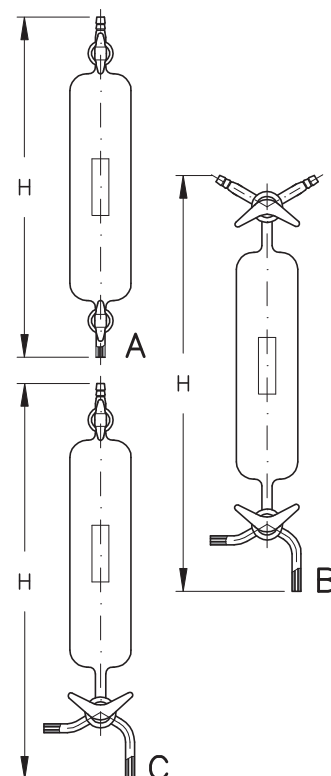

FILTER DISCS

Filter discs are available with different porosity and diameters. The edge of the filter discs is centred and not fused.



Please add the figure for the porosity to the catalogue number in your order

Figure for porosity	max. pore size
0	160µ - 250µm
1	100µ - 160µm
2	40µ - 100µm
3	16µ - 40µm
4	10µ - 16µm



Filter disc -Ø (F)	Catalogue No.
5	HAA 60170 01
10	HAA 60170 02
20	HAA 60170 03
25	HAA 60170 04
30	HAA 60170 05
40	HAA 60170 06
50	HAA 60170 07
60	HAA 60170 08
65	HAA 60170 09
70	HAA 60170 10
80	HAA 60170 11
90	HAA 60170 12
100	HAA 60170 13
120	HAA 60170 14

REVERSING FRITS

These reversing frits, available in different porosity, serve for filtration of oxidation and hydrolysis when sensitive substances are often used in organo-metallic chemistry. They are fitted with standard stopcock, bore 3 mm.

 Please add the figure for the porosity to the catalogue number in your order

Figure for porosity	max. pore size
0	160 μ - 250 μ
1	100 μ - 160 μ
2	40 μ - 100 μ
3	16 μ - 40 μ
4	10 μ - 16 μ

with single way stopcock

Capacity (ml)	NS	H	D	Frit \varnothing (mm)	Catalogue No.
25	14/23	135	11	20	LSG 08200 11
50	14/23	155	11	30	LSG 08200 21
100	14/23	200	11	30	LSG 08200 31
100	29/32	200	11	30	LSG 08198 11
250	14/23	280	11	40	LSG 08200 41
250	29/32	280	11	40	LSG 08198 21
500	29/32	300	11	60	LSG 08198 31
1000	29/32	350	11	80	LSG 08198 41

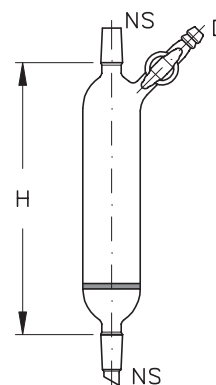

with single way stopcocks and outlet pipe

Capacity (ml)	NS	H	D	GL	Frit \varnothing (mm)	Catalogue No.
25	14/23	165	11	14	20	LSG 08190 11
50	14/23	185	11	14	30	LSG 08190 21
100	14/23	225	11	14	30	LSG 08190 31
100	29/32	225	11	14	30	LSG 08191 11
250	14/23	305	11	14	40	LSG 08190 41
250	29/32	305	11	14	40	LSG 08191 21
500	29/32	325	11	14	60	LSG 08191 31
1000	29/32	370	11	14	80	LSG 08191 41

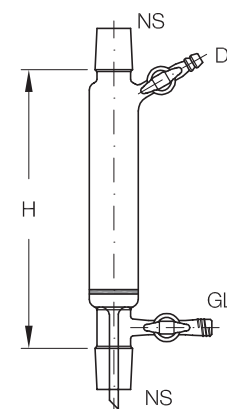

All ground joints are also available in other standard sizes, e.g. US-standard.

WASHING BOTTLES

These devices are used in front of reaction apparatus to clean the introduced gas flow. Available in two different designs, as washing bottle and as safety washing bottle with integrated safety volume.

Washing bottles

When these simple bottles are used it is recommended to fit a second empty washing bottle between the reaction apparatus and the washing bottle. Its volume should be so chosen, that it can collect the whole reaction solvent in the event of underpressure in the gas introduction line or overpressure in the apparatus. A mixture with the washing liquid will be avoided in case of an accident.

In design A the gas is introduced via a tube and in design B via a tube with sealed frit into the washing liquid. The frit serves for a fine distribution of the gas what causes a better purifying.

Capacity (ml)	H	NS	Frit porosity	GL	Des.	Catalogue No.
100	250	29/32	-	14	A	ALG 00503H 01
250	250	29/32	-	14	A	ALG 00503H 02
250	250	29/32	D1	14	B	ALG 00504 02
250	250	29/32	D2	14	B	ALG 00504 12
500	250	29/32	-	14	A	ALG 00503C 01
500	250	29/32	D1	14	B	ALG 00504C 01
500	250	29/32	D2	14	B	ALG 00504C 11

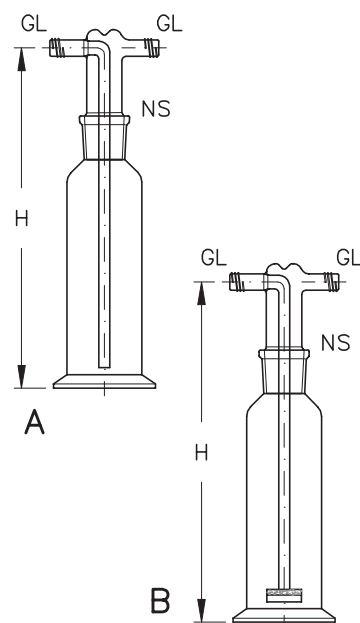

Safety washing bottles

The safety function of this washing bottles works in this way, that the reaction solvent and washing liquid cannot mix each other in case of an accident. The bottles are available either with frit (design A) or with glass disc, with hole, on the lower end of the inner cylinder (design B).

The washing liquid, filled up to the indicated mark over the thread connection GL 32 with screw cap, is in the inner cylinder during normal operation, i.e. above the frit or glass disc. The liquid will be pressed or absorbed to the outer room when underpressure in the gas introduction line or overpressure in the apparatus occur. After the normalisation of the operating conditions the former condition will be re-established.

Capac. (ml)	H	Frit porosity	Number bore	Hole-Ø	Gas through-put (l/h)	GL	Des.	Catalogue No.
200	250	D0	-	-	up to 80	14	A	ALG 00497 00
200	250	D1	-	-	up to 80	14	A	ALG 00497 01
200	250	-	21	1.5	-	14	B	ALG 00496 00
300	250	D0	-	-	up to 90	14	A	ALG 00499 00
300	250	D1	-	-	up to 90	14	A	ALG 00499 01
300	250	-	25	1.5	-	14	B	ALG 00496 01
500	250	D0	-	-	up to 130	14	A	ALG 00498 00
500	250	D1	-	-	up to 130	14	A	ALG 00498 01
500	250	-	25	2.0	-	14	B	ALG 00496 02

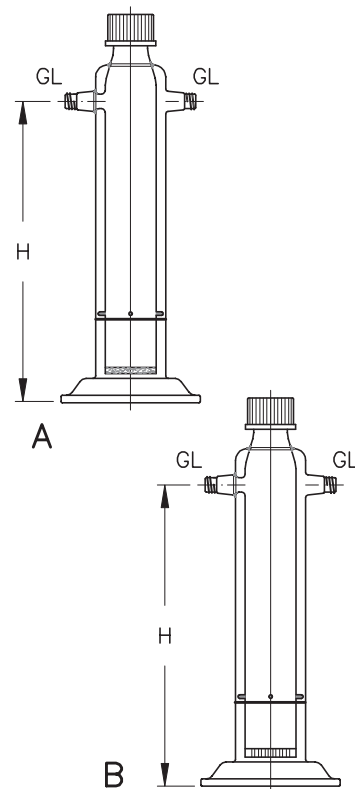

COLD TRAPS

They are used to reach an increased vacuum throughout the condensing of volatile components in general vacuum distillation. Can also be used in high vacuum distillation and to avoid contamination of the pump oil. Cold traps are also indispensable for distillation of substances which boil under 100 °C at normal pressure and when via the distillate drain is made up the balance.

The media to be cooled flows forced guided, the way is twice as long as the height of the cold trap, and will be cooled at a relative big surface compared to the flow section. The loss of vacuum caused by the trap is minimally.

Capacity (ml)	H	NS	NS1	D	Des.	Catalogue No.
-	450	29/32	-	-	A	LSG 09217
-	450	45/40	-	-	A	LSG 09218
-	300	29/32	-	-	B	LSG 09215
-	300	45/40	-	-	B	LSG 09216
100	270	29/32	29/32	-	C	LSG 09224 00
250	320	45/40	29/32	-	C	LSG 09225 00
100	270	29/32	-	11	D	LSG 09222 00
250	320	45/40	-	16	D	LSG 09223 00

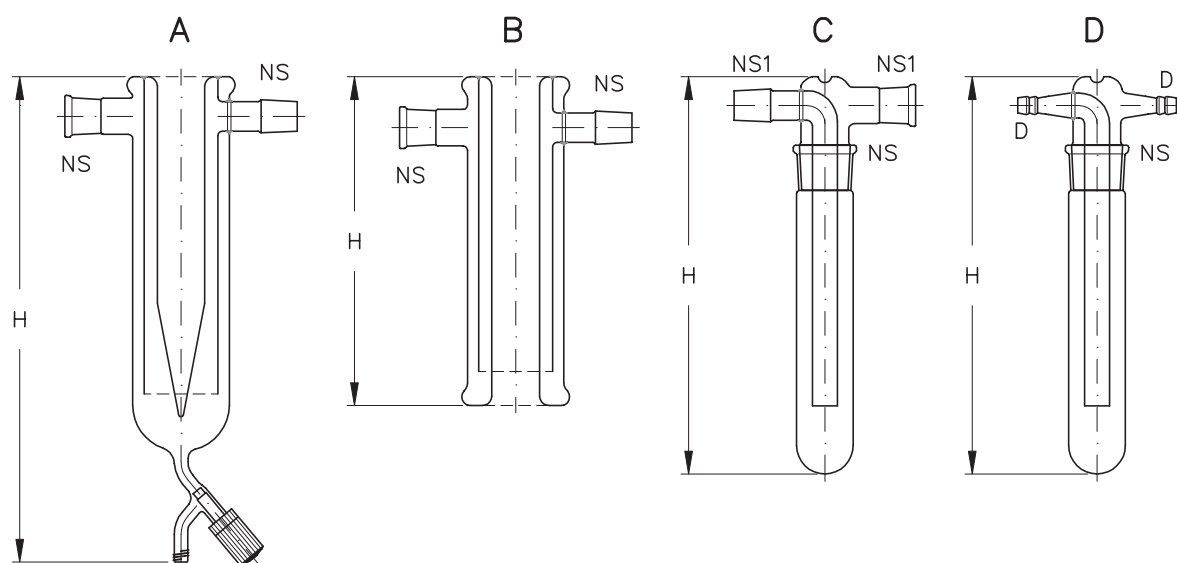

All ground joints are also available in other standard sizes, e.g. US-standard.

Cold trap systems

They are used, e.g. for continuously distillation, to avoid a freezing of the falling tubes in water containing distillates and thereby caused trouble of the process. An easy exchange of the cold traps, which are fitted with spherical ground joints, is guaranteed through switching off the PTFE spindle valve under normal pressure as well as under vacuum. A pair wise arrangement is recommended, so the distillate drain not needing to be stopped.

The individual parts of the cold trap are interchangeable with each other.
The cold traps are delivered ready for use.

Capacity (ml)	Catalogue No.
500	VAB 09213 05

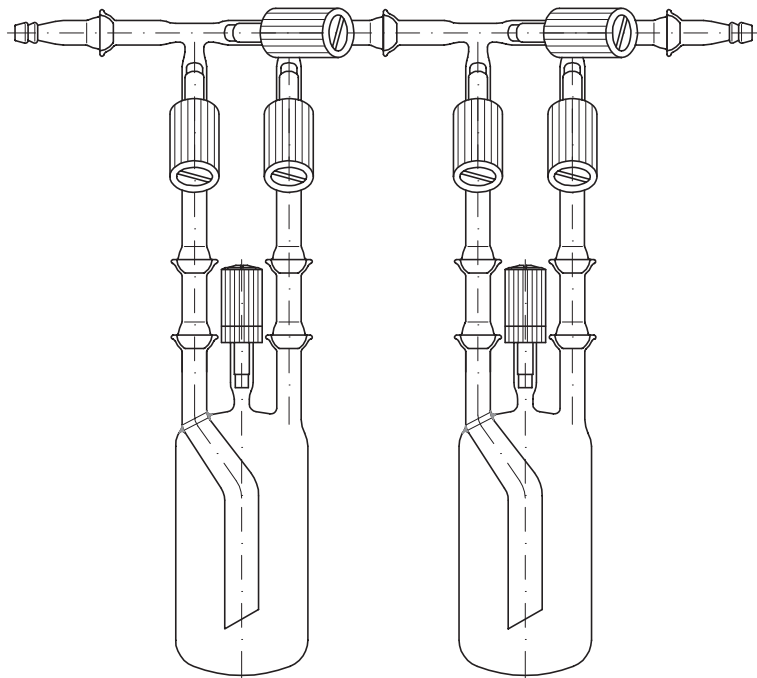

WATER-JET VACUUM PUMP

These mechanical robust water jet pumps are fitted with an injector and provides a high pumping speed. The ultimate reachable vacuum depends on the form of the nozzle and the temperature of the fed water and is approx. 16 mbar.

Catalogue No. LSG 00509

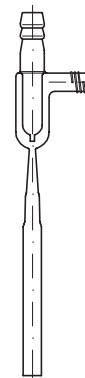

LABORATORY GLASS PUMP

These corrosion resistant pumps without stuffing box are available in two sizes. They have been designed for use in laboratories and are suitable for pumping off pure liquids or lower viscous liquids which are contaminated with slight parts of solid substances. The lubricating properties of the liquid have a secondary importance for the run of the pump due to the pump construction. The allowed operating conditions are 1 bar/150 °C.

The pumps mainly consists of the two-part pump body made of Borosilicate glass 3.3, the PTFE-pump rotor with integrated counter magnet, the magnet rotor with electric drive and the control unit. This control unit allows a rev adjustment from 2000 min⁻¹ to 2500 min⁻¹. To avoid a side wise start the pump rotor is guided on a glass cone, sealed in the lower body part.

To be able to air the pump body, the upper part of the body is equipped with a ventilation stopcock (bore 3 mm). After ventilation of the body and suction pipe the pumps are self-priming.

Micro design

Upper and lower part of the body are connected together with flat flanges with nominal size DN 50. Suction pipe and pressure pipe have spherical ground joints S 19 (ball and cup).

Catalogue No. SAA 09315

